



AP-FHP-0100-R AP-FHP-0105-R AP-FHP-0105-T

Hyper PoE Extender



Long Range Solution • Quick Installation • Flexible Connection

Introduction

The Hyper PoE Extender for IP cameras is a long-range solution providing Fast Ethernet and Power over Ethernet cables up to 1,200m. This product line is the best solution for IP video surveillance in cases of long-distance applications. By adopting VIVOTEK'S Hyper PoE Extender, our customers no longer require a fiber cable for data transmission over distances above 300m, thereby saving on wiring and extra installation costs. In addition, the Hyper PoE Extender transmits both power and data to IP cameras whereas fiber solutions only provide data, further reducing installation and maintenance expenditure.

Key Features

- Extend Ethernet and Power up to 1,200m (3,937 ft) over Cat 5e Ethernet Cable
- Support Ring Topology up to 4 IEEE 802.3af Camera for Power Redundancy
- Support Daisy Chain Topology up to 4 IEEE 802.3af Camera
- Easy Installation
- Both Wall Mount and Rackmount Supported

Application

Daisy Chain 400M

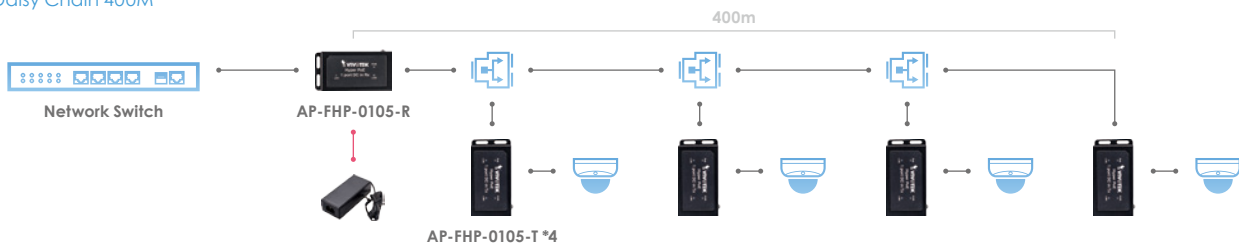

Ring 400M

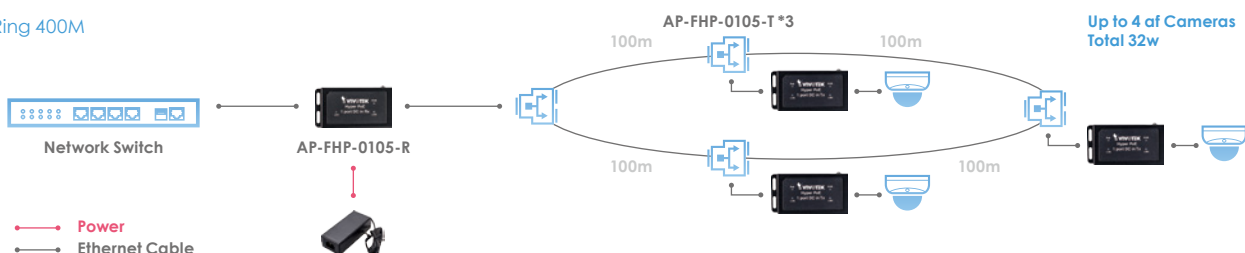

— Power
— Ethernet Cable

Distance/Power Table

AP-FHP-0105-T

Length of Ethernet Cable (Cat 6)	Power with AA-420 65 Watt	Power with PoE Switch 30 Watt	Power with AP-GIC-011A-060 60 Watt AP-GIC-011A-095 95 Watt*
300 m (984 ft)	41.2 W	8.8 W	27.7 W
500 m (1,640 ft)	23.9 W	5 W	17.2 W
800 m (2,625 ft)	14.7 W	-	10.5 W
1000 m (3,281 ft)	11.7 W	-	8.2 W
1200 m (3,937 ft)	8.8 W	-	5.9 W
2400 m (7,873 ft)	Data only (100Mbps)	Data only (100Mbps)	Data only (100Mbps)

NOTE:

1. The power table is measured by VIVOTEK's PoE switch and PoE injector.
 2. The length of network cable for camera and switch connection is 1m Cat6 cable.
 3. The power delivery will vary depending on the quality of Cat6 cable used due to variations in resistance.
- *Due to the current limit and resistance in long length, the output will be the same as 60 Watt.

Solution Kit

Ordering Information

Model	Content	Description	P/N
AP-FHP-0100-R	AP-FHP-0100-R	1 Port Hyper PoE Rx Module, PoE input	900057600G
		1 Port Hyper PoE Rx Module, USA	100216800G
		1 Port Hyper PoE Rx Module, EU	100216810G
AP-FHP-0105-R	AP-FHP-0105-R + AA-420	1 Port Hyper PoE Rx Module, UK	100216820G
		1 Port Hyper PoE Rx Module, AU	100216830G
		1 Port Hyper PoE Rx Module, JP	100216840G
AP-FHP-0105-T	AP-FHP-0105-T	1 Port Hyper PoE Tx Module	900057700G

DC input

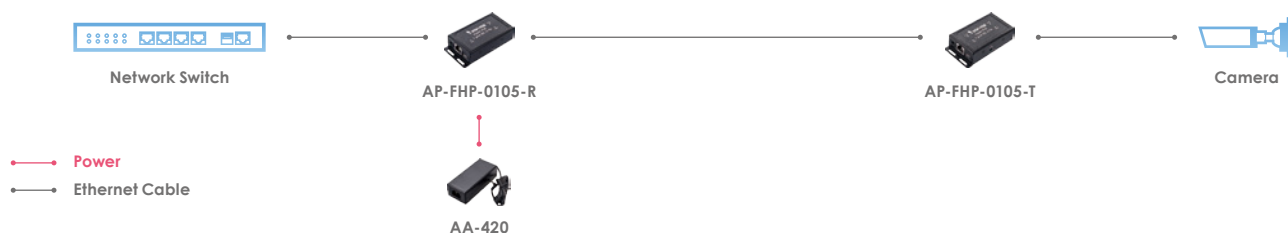

PoE input

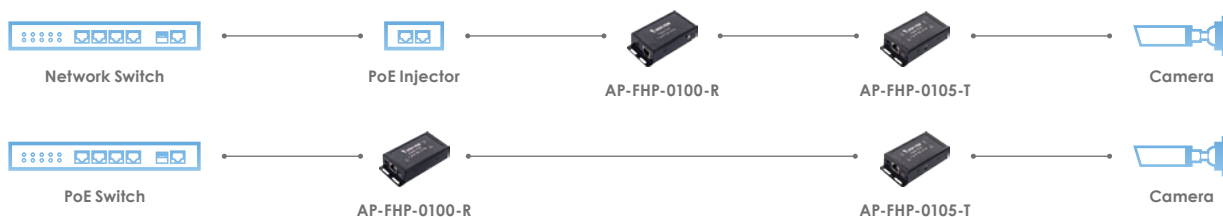

Note: VIVOTEK's Hyper PoE Rx modules are only compatible with Hyper PoE Tx modules
 Note: It is not recommended to install these in outdoor environments

Technical Specifications



Model	AP-FHP-0100-R	AP-FHP-0105-R	AP-FHP-0105-T
Product Description	1 Port Hyper PoE Rx Module, PoE input	1 Port Hyper PoE Rx Module	1 Port Hyper PoE Tx Module
Hyper PoE Port	1x FE RJ45 Power Pin 1~4(-), 5~8(+)	1x FE RJ45 Power Pin 1~4(-), 5~8(+)	1x FE RJ45 Power Pin 1~4(-), 5~8(+)
Ethernet Port	1 x FE RJ45, 30/60/95W PoE input	1 x FE RJ45	1 x FE RJ45, PoE output 1/2(+), 3/6(-), 4/5(+),7/8(-)
DC Jack	-	1	1
PoE on/off Switch	-	-	1
Transmission Mode	Rx	Rx	Tx
Max. PoE Distance (Cat 6)	8.8W @1200m, 100Mbps		
Max. Ethernet Distance (Cat 6)	2400m, 100Mbps		
Power Input	30/60/95W PoE input	DC 56V	DC 56V or Hyper PoE
Power Consumption	3W	3W	3W
PoE Standard	IEEE 802.3 bt	-	-
Dimension	102.9 x 48.9 x 23.4 mm	109 x 51.5 x 24 mm	109 x 51.5 x 24 mm
Weight	156 g	169 g	169 g
Operating Temperature	-20°C ~ 60°C (-4°F ~ 140°F)		
Storage Temperature	-20°C ~ 85°C (-4°F ~ 185°F)		
Operating Humidity	5% ~ 95% non-condensing		
Safety Certification	CE, FCC, VCCI, C-Tick	CE, FCC, VCCI, C-Tick	CE, FCC, VCCI, C-Tick

Dimension

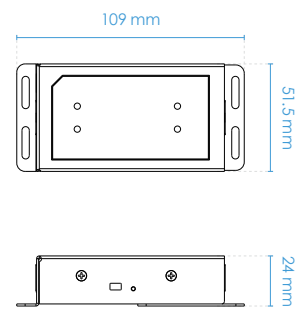
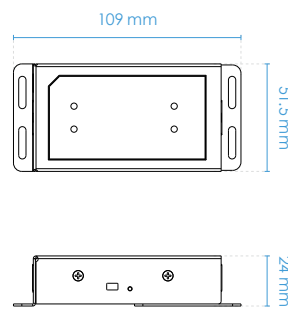
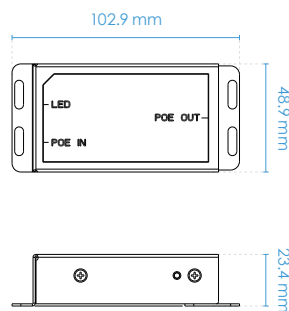

Optional Accessories

Power Adapter	PoE Injector	
 <p data-bbox="209 398 472 465">AA-420 65W@56V Power Adapter for AP-FEX-0105-R</p>	 <p data-bbox="711 398 879 443">AP-GIC-011A-060 For AP-FHP-0100-R</p>	 <p data-bbox="1166 398 1334 443">AP-GIC-011A-095 For AP-FHP-0100-R</p>